



Gas Essentials^{INC}

Natural and Propane Gas Regulation, Measurement and Controls



Distributed By

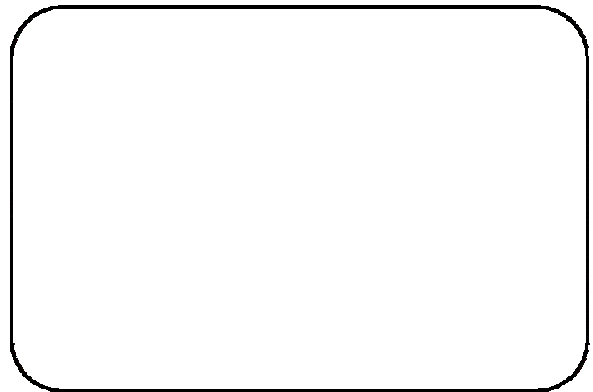

SZ Turbine Meters

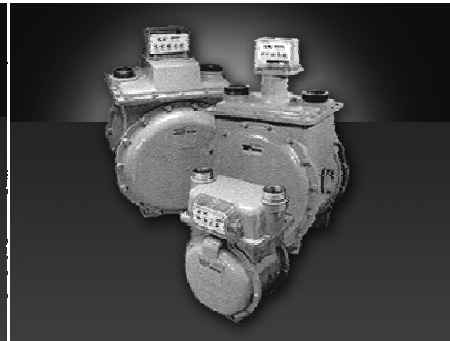

www.gasesentials.com

SZ Turbine Meters



◀ SZ-65

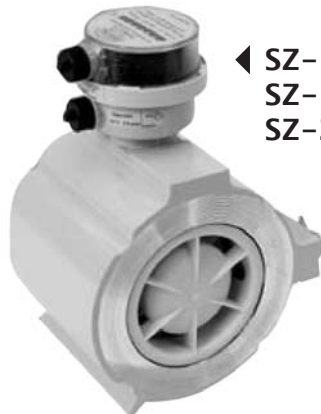

◀ SZ-100
SZ-160
SZ-250



▼ SZ-1
SZ-2



SZ-40 ▶

Connections •

1" Female NPT

1 1/2" Female NPT

For installation
between ANSI 150
flanges. { 2" Wafer
3" Wafer
4" Wafer

Recommended for indoor application only

Features

- Lightweight, Aluminum Construction
- Maximum Working Pressure 175 PSI
- Permanently Lubricated Bearings
- Low Frequency / High Frequency Pulse Output Standard
- Rugged Mechanical Index Rotatable Through 360°
- Self Supporting Line Mount Design
- Mount in Any Position
- Direct Read Odometer Type Index
- Rangeability: 20 - 1
- Operating Temp. 0°F. - +140°F.

Rated Capacity (SCFH) at Operating Pressure

Pressure PSI	SZ-1	SZ-2	SZ-40	SZ-65	SZ-100	SZ-160	SZ-250
4 oz.	900	1500	2300	3500	5600	8800	15000
2	1020	1700	2610	3975	6360	9990	17040
5	1200	2000	3080	4690	7500	11795	21100
10	1500	2500	3860	5880	9410	14785	25200
15	1820	3000	4650	7070	11315	17780	31400
20	2125	3540	5340	8260	13220	20770	35400
25	2430	4050	6210	9450	15125	23765	40500
30	2735	4560	7000	10640	17030	26760	45600
40	3350	5580	8560	13025	20840	32750	55800
50	3950	6600	10120	15400	24650	38730	66000
60	4560	7620	11690	17790	28450	44720	76200
75	5550	9150	14035	21350	34170	53700	91530
100	7000	11700	17950	27310	43700	68670	117040
125	8540	14250	21800	33260	53220	83630	142550
150	10060	16800	25760	39210	62740	98600	168060
175	11600	19350	45160	45160	72270	113560	193575

* Capacities based on 14.73 Atmospheric Pressure and 14.73 Base Pressure

Dimension Data

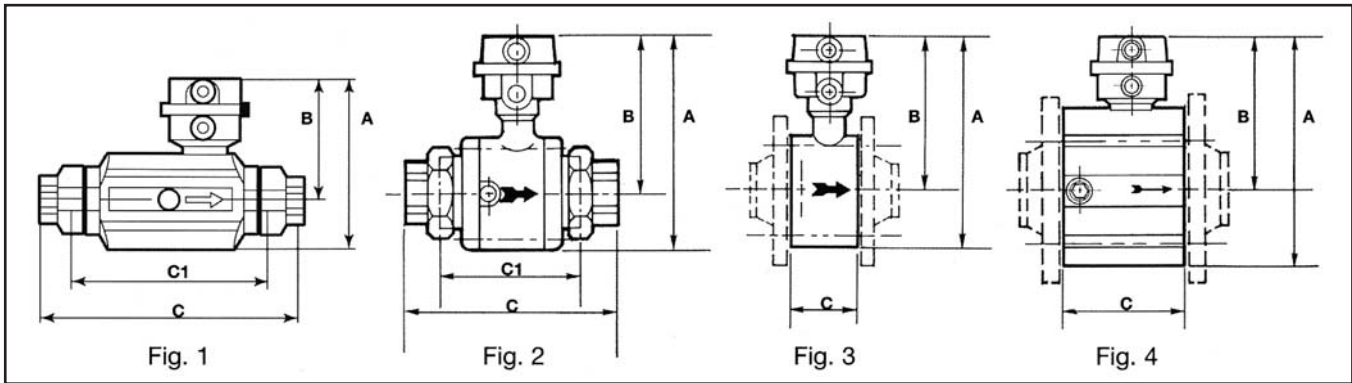

Pressure Drop at Capacity

Model	Fig.	Pipe Size/Connection	C	C1	A	B	Inches Water Column	m Bar	Weight (lbs)	Shipping Wt. (approx.)
SZ-1	1	1" FNPT	9.45"	7.28"	6.26"	4.56"	0.9	2.2	4	7
SZ-2	1	1" FNPT	9.45"	7.28"	6.26"	4.56"	2.2	5.5	4	7
SZ-40	2	1-1/2" FNPT	7.5"	5.0"	7.95"	5.9"	2.4	6.0	7	8
SZ-65	3	2" ANSI 150 Wafer	2.36"	-	7.95"	5.9"	4.8	12.0	3	7
SZ-100	4	3" ANSI 150 Wafer	4.73"	-	8.86"	5.9"	2.6	6.5	9	18
SZ-160	4	3" ANSI 150 Wafer	4.73"	-	8.86"	5.9"	5.6	14.0	9	18
SZ-250	4	4" ANSI 150 Wafer	5.9"	-	9.65"	6.5"	3.2	8.0	12	23

Pulse Output Data

Model	Low Frequency E1 Form "A" Reed Switch Cubic Feet/Pulse	High Frequency E200 Proximity Sensor Pulses/Cubic Feet
SZ-1	1	50
SZ-2	1	50
SZ-40	10	25
SZ-65	10	25
SZ-100	100	2.5
SZ-160	100	2.5
SZ-250	100	2.5

Technical Data

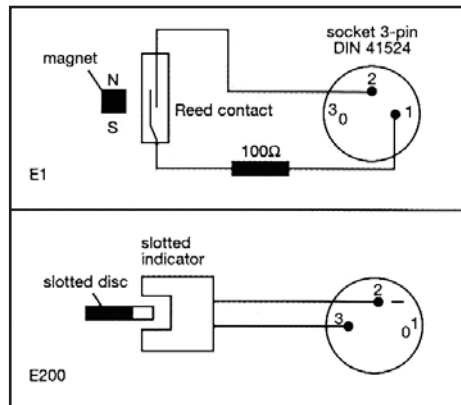

E1 (series) reed contact

Max. Voltage: 24 Vdc
 Max. Current: 50mA
 Max. Capacity: 25 Watts
 Resistance: 100Ω ± 20%

E200 pulser

Standard Voltage:
 $U_n = 8\text{VDC}$
 Current consumption:
 active surface open: 1 □ 2.1mA
 active surface closed: 1 □ 1.2mA

Models SZ-65 to SZ-250

The accuracy curve illustrates that the error over the maximum capacity range is within guaranteed limits. An increase of density e.g. higher line pressure - does not change the accuracy

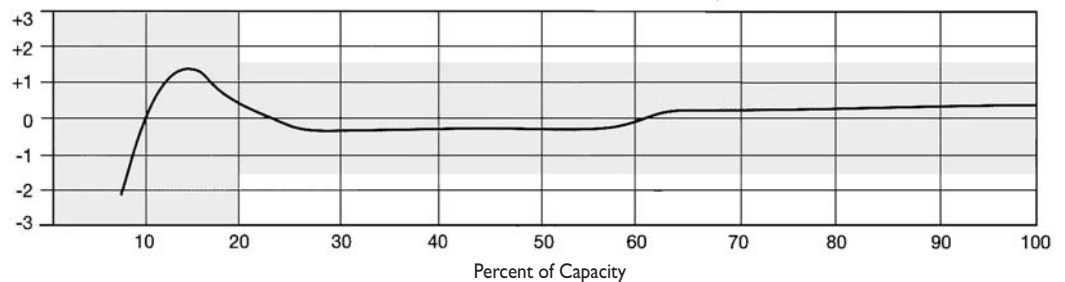

Other products available from



.....
**Regulators for Natural & Propane Gas
High Pressure Regulators up to 5000 PSI
Filter Regulators & Gauges**

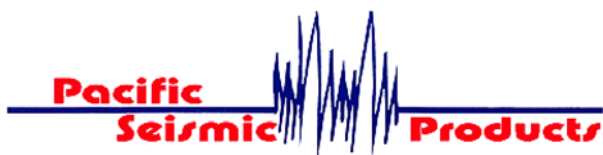

.....
**Seismic "Earthquake" Valves
available from 3/4" to 8"**

MILLIKEN

.....
**Lubricated two way & three way Plug Valves
CSA/CGA Approved**

Manufacturer standard warranty applies. For a copy please contact us.